

HIGH BAY

120Watt High Bay within Industrial Unit
Ballymount, Dublin

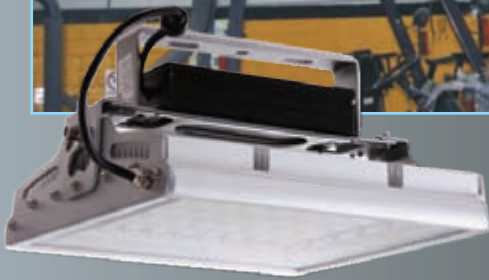

FLHI-D60WD

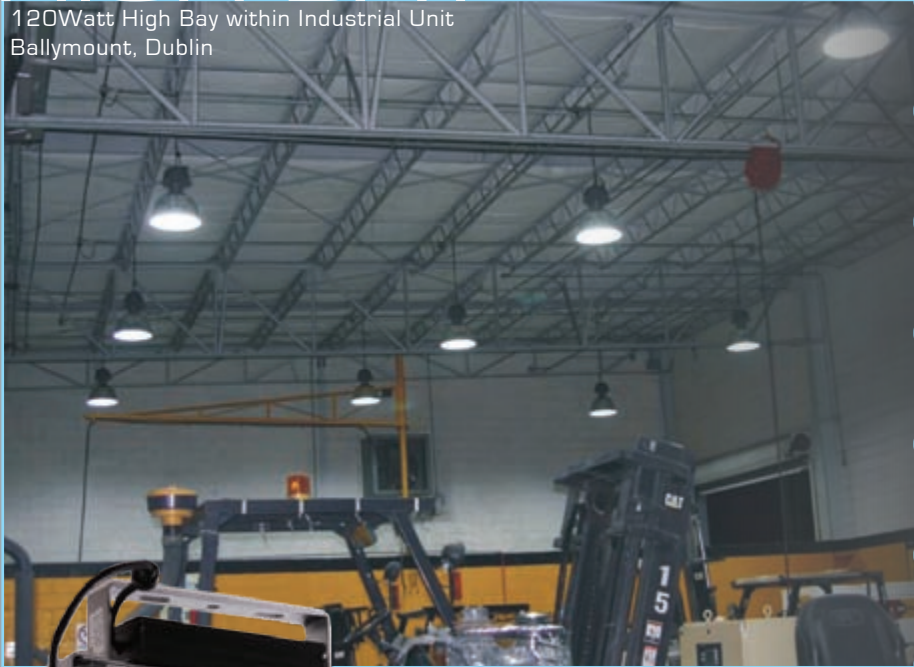
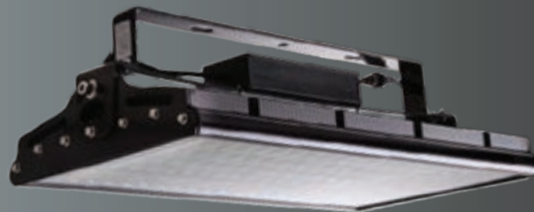

FLHI-D90WD

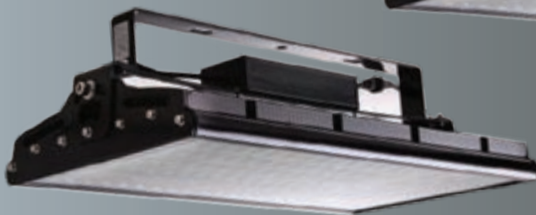

FLHI-D120WD

HIGH BAY/INDUSTRIAL SERIES

The FibreLED Industrial/High Bay range offers a robust aluminium housing that dissipates heat from the light fixtures array of LEDs. The FLHI-D range provides super directional downward lumens to industrial, commercial warehousing, parking and other areas that need high task lighting requirements. LED emits no UV radiation and is 100% mercury free. Low operating temperature, CE approval. The FLHI-D range will offer up to 50,000hrs maintenance free industrial lighting.

HIGH BAY/INDUSTRIAL SERIES

FL HI120

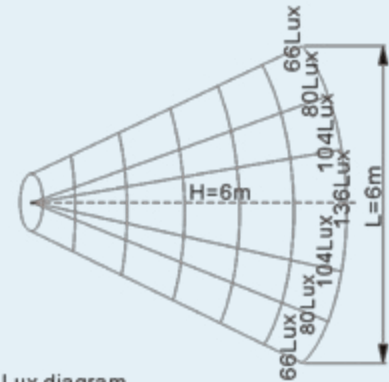
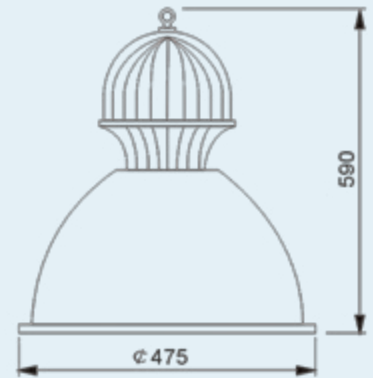

Lux diagram

Wattage:	120w
Lumen Output:	9900lms
Beam Angle:	80°/130°/170°
Colour Ra Index:	80ra
Housing:	Aluminium Alloy, Glass Cover
Colour Temp:	5000-6000 cold
IP Rating:	IP65
Energy Saving:	80% Consumption Saving
Warranty:	2 years



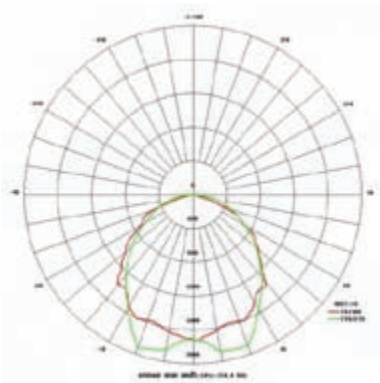
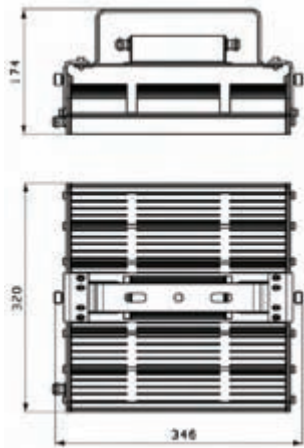

LED QTY, LED Power	60pcs, 60W
Total Power	67W
Input Voltage	90 - 264 V AC
Frequency Range	50 - 60 Hz
Power Supply Efficiency	≥90%
LED Initial Luminous Flux	6,000 lm (Ta=25°C)
LED Maintain Luminous Flux	5,400 lm (Ta=25°C)
Colour Temperature (CCT)	Cool White: 6 - 6,500 Pure White: 5 - 5,500 Warm White: 3 - 3,500
Colour Index (CRI)	Pure White: Ra ≥75 Warm White: Ra ≥80
Beam Angle (50%)	Vertical Axis: 107° Horizontal Axis: 98°
Beam Angle (10%)	Vertical Axis: 151° Horizontal Axis: 162°
Center Illuminated Area (E) (50% Beam Angle)	H=4m ≥112.60lux H=5m ≥72.04lux H=6m ≥50.03lux
Average Illuminated Area (E) (50% Beam Angle)	H=4m ≥38.50lux H=5m ≥24.64lux H=6m ≥17.11lux
IP Rating	IP 65
Lifespan	50,000hrs life 3yrs Warranty
Light Body & Shade	Aluminium and Reinforced Glass
Dimension	346 x 320 x 174
Net Weight	8.5 kgs
Packing Manner	1pc/ Carton
Packing Dimension	562 x 432 x 265mm
Packing Gross Weight	10.0 kgs
Listing	CE, RoHS, FCC

LED QTY, LED Power	90pcs, 90W
Total Power	100W
Input Voltage	90 - 264 V AC
Frequency Range	50 - 60 Hz
Power Supply Efficiency	≥90%
LED Initial Luminous Flux	9,000 lm (Ta=25°C)
LED Maintain Luminous Flux	8,100 lm (Ta=25°C)
Colour Temperature (CCT)	Cool White: 6 - 6,500 Pure White: 5 - 5,500 Warm White: 3 - 3,500
Colour Index (CRI)	Pure White: Ra ≥75 Warm White: Ra ≥80
Beam Angle (50%)	Vertical Axis: 107° Horizontal Axis: 98°
Beam Angle (10%)	Vertical Axis: 151° Horizontal Axis: 162°
Center Illuminated Area (E) (50% Beam Angle)	H=6m ≥80.16lux H=7m ≥58.89lux H=8m ≥45.09lux
Average Illuminated Area (E) (50% Beam Angle)	H=6m ≥30.15lux H=7m ≥22.15lux H=8m ≥16.96lux
IP Rating	IP 65
Lifespan	50,000hrs life 3yrs Warranty
Light Body & Shade	Aluminium and Reinforced Glass
Dimension	476 x 320 x 174mm
Net Weight	10.8 kgs
Packing Manner	1pc/Carton
Packing Dimension	692 x 432 x 265
Packing Gross Weight	12.5 kgs
Listing	CE, RoHS, FCC

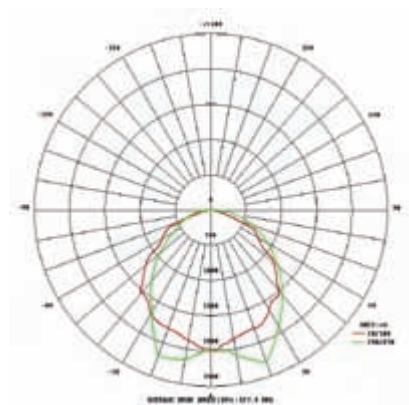
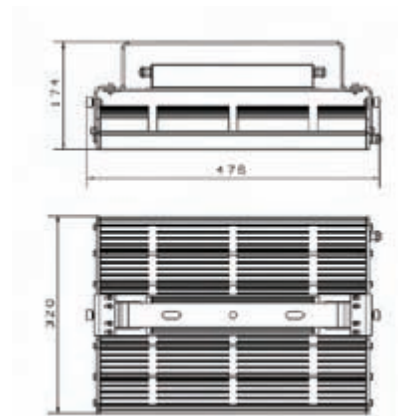

FLHI-D120WD

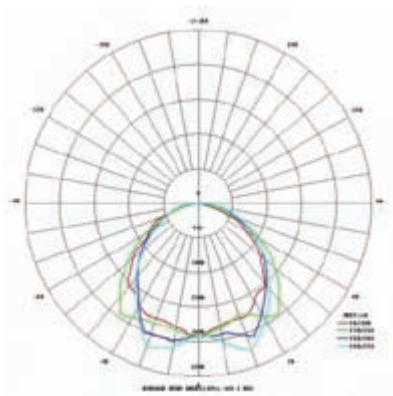
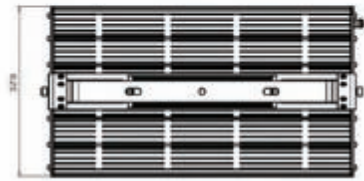

LED QTY, LED Power	120pcs, 120W
Total Power	133W
Input Voltage	90 - 264 V AC
Frequency Range	50 - 60 Hz
Power Supply Efficiency	≥90%
LED Inital Luminous Flux	12,000 lm (Ta=25°C)
LED Maintain Luminous Flux	10,800 lm (Ta=25°C)
Colour Temperature (CCT)	Cool White: 6 - 6,500 Pure White: 5 - 5,500 Warm White: 3 - 3,500
Colour Index (CRI)	Pure White: Ra ≥75 Warm White: Ra ≥80
Beam Angle (50%)	Vertical Axis: 107° Horizontal Axis: 98°
Beam Angle (10%)	Vertical Axis: 151° Horizontal Axis: 162°
Center Illuminated Area (E) (50% Beam Angle)	H=4m ≥56.40lux H=5m ≥44.56lux H=6m ≥36.09lux
Average Illuminated Area (E) (50% Beam Angle)	H=4m ≥19.96lux H=5m ≥15.77lux H=6m ≥12.77lux
IP Rating	IP 65
Lifespan	50,000hrs life 3yrs Warranty
Light Body & Shade	Aluminium and Reinforced Glass
Dimension	606 x 320 x 174
Net Weight	12.9 kgs
Packing Manner	1pc/Carton
Packing Dimension	822 x 432 x 265
Packing Gross Weight	15.0 kgs
Listing	CE, RoHS, FCC