

 **LUZ NEGRA**
linear lighting solutions

fibreLED

LED Lighting Specialists

www.fibreled.com

Cut&Connect
by Luz Negra

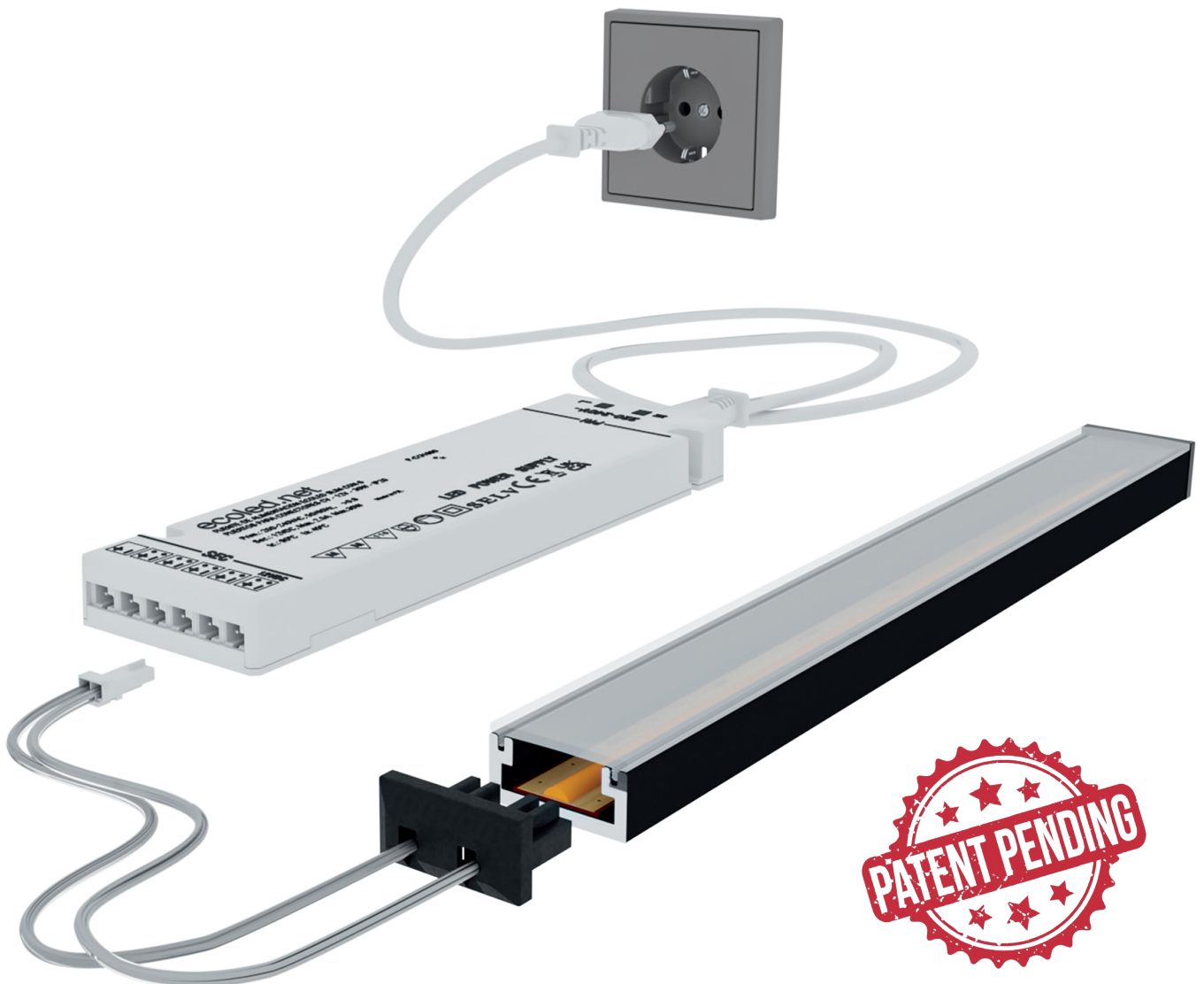

Designed and manufactured in: Spain



Cut&Connect

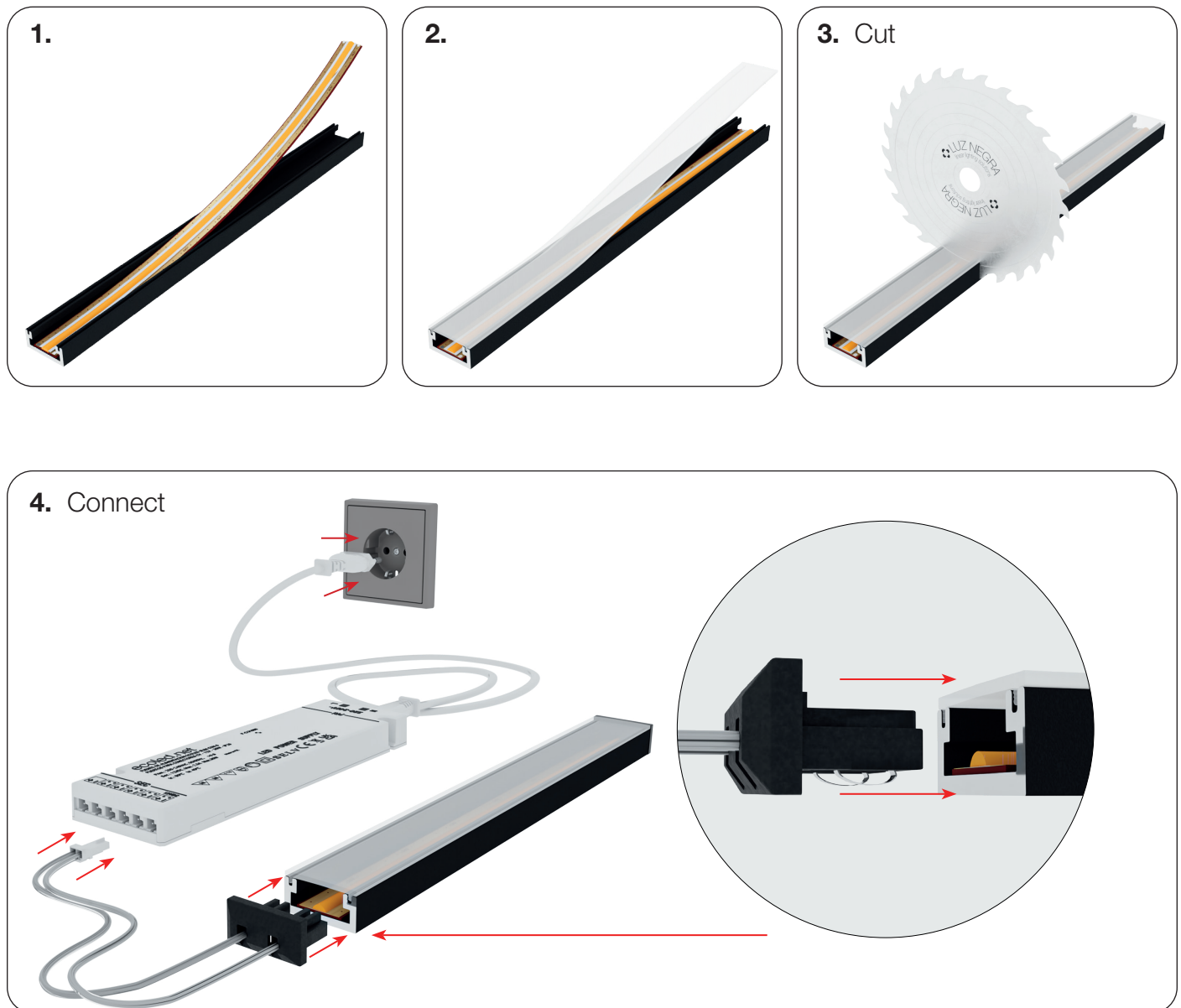

Linear lighting system designed to create custom luminaires quickly and easily, without the need for any soldering or specialised labour.

Cut&Connect allows us to cut the profile with the cover and the LED strip simultaneously and at any place, without needing to find a specific cutting point. This is possible thanks to the Elite GOLD LED strip's technology (virtually **Free Cut**), which ensures uniform lighting from end to end, without any shadows at the edges, even when the luminaire length does not match multiples of the strip's cutting points.

The LED strip has **COB** technology incorporated inside, providing continuous linear light with a dot-free effect, even in shallow profiles.

Additionally, the endcap with connector cable enables manual connection between the profile (luminaire) and the power supply with a simple "click", meaning no soldering, tools or specially qualified personnel needed.

Profile

The Cut&Connect system is available in our 5 most popular profiles: 2 for surface-mounting, 2 for recessing, and 1 for corners. All of them are available in silver or black anodised and come with IP65 certification issued by Applus.

To ensure this level of watertight protection, a small amount of silicone must be applied to the inside of the endcap (that has the cable and connector).



IP65



Milano



Roma



Frankfurt



Berlin



Sophia

Covers

Cut&Connect offers up to 7 different types of covers, each with different levels of light transmission. All covers are compatible with any of the profiles and are made with **30%** recycled material. In addition, they are available in lengths ranging from 2 metres to 60-metre rolls, allowing for the creation of continuous luminaires with no visible joints, maximising material efficiency.

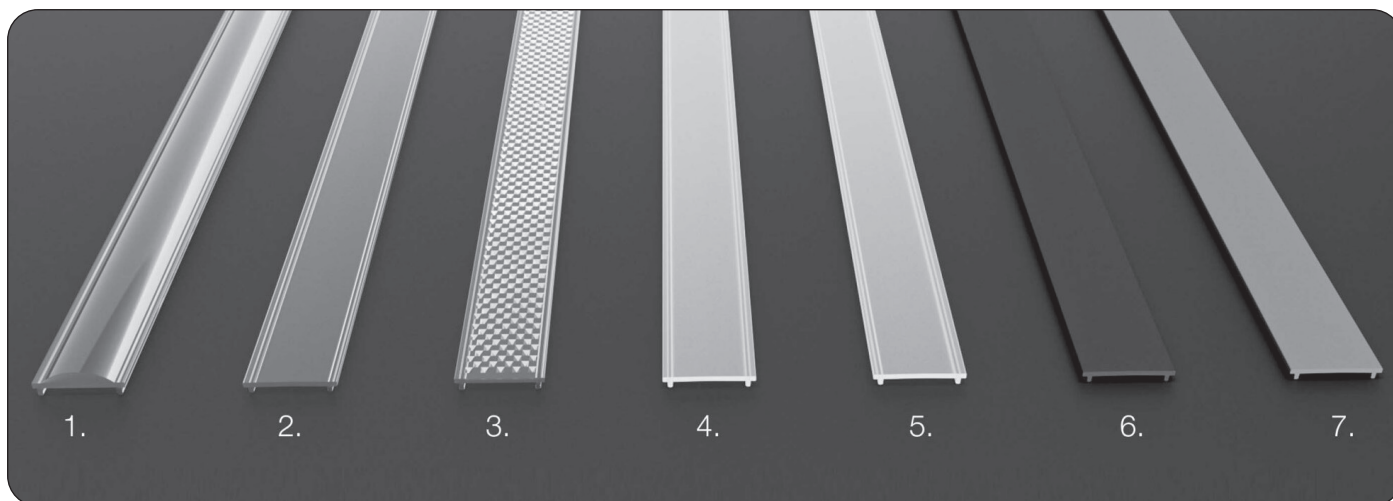

- | | |
|---|--|
| 1. With lens: 90% light transmission. | 5. Opal: 60% light transmission. |
| 2. Transparent: 90% light transmission. | 6. Black&white: 25% light transmission. |
| 3. Transparent microprism: 85% light transmission. | 7. Opaque grey: 0% light transmission. |
| 4. Frosted: 70% light transmission. | |

LED

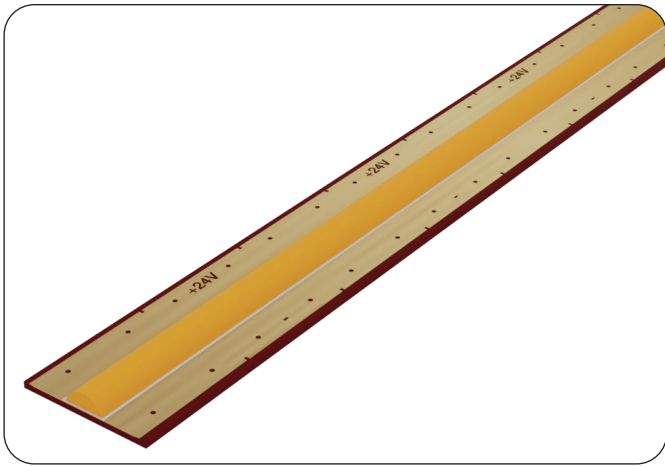

Cut&Connect features the COB LED strip, **Elite GOLD** model, specifically designed to allow cutting at any point. This makes it easy to adjust the luminaire length with millimetre precision, while ensuring uniform lighting from end to end.

Thanks to its **COB** technology, it delivers continuous illumination with a dot-free effect and its high CRI (above 90) guarantees excellent light quality.

The **Elite GOLD** COB strip used in Cut&Connect is available in 4 different power outputs:

5W 10W 15W 20W

In 5 white tones:

2400K 2800K 3000K 4000K 5000K

Its continuous soldering pad with a fine gold layer on the surface ensures superior connectivity, minimises voltage drop and protects the strip from oxidation, increasing its durability and performance.

Additionally, the Elite GOLD strip is supplied in 6-metre rolls, unlike the conventional 5-metre format. This length is a multiple of the most common profile sizes (**2m**, **3m** and **6m**), allowing for an optimised use and therefore reduced waste.



Power supplies

Cut&Connect has been designed for use with our Ecoled power supplies with multi-connectors, which are high-quality devices that comply with all lighting regulations and feature a minimal height, making them easy to conceal within furniture or in compact spaces.

The multi-connector power supplies are available in four power ratings: **36W**, **65W**, **100W** and **200W**, all operating at **24V**.

While conventional power supplies can also be used, we recommend our multi-connector models for the following reasons:

Quick and easy connection: luminaires can be connected with a simple click, no tools required, speeding up the installation process.

Extended connectivity: with multiple connection ports, between 7 and 10 luminaires can be connected to a single power supply, optimising the lighting system.

Sensor compatibility: a lateral port allows for the connection of sensors for switching on/off and for dimming the connected luminaires, enhancing the system's functionality and energy efficiency.

For installations where the power supply is located more than 1 metre away from the luminaire, we offer a 200cm extension cable fitted with male-female DuPont connectors at both ends. This acts as an extension lead, making it easy to connect the luminaire to the power supply even at a considerable distance.

Wiring diagram for radio-frequency dimmable control system:

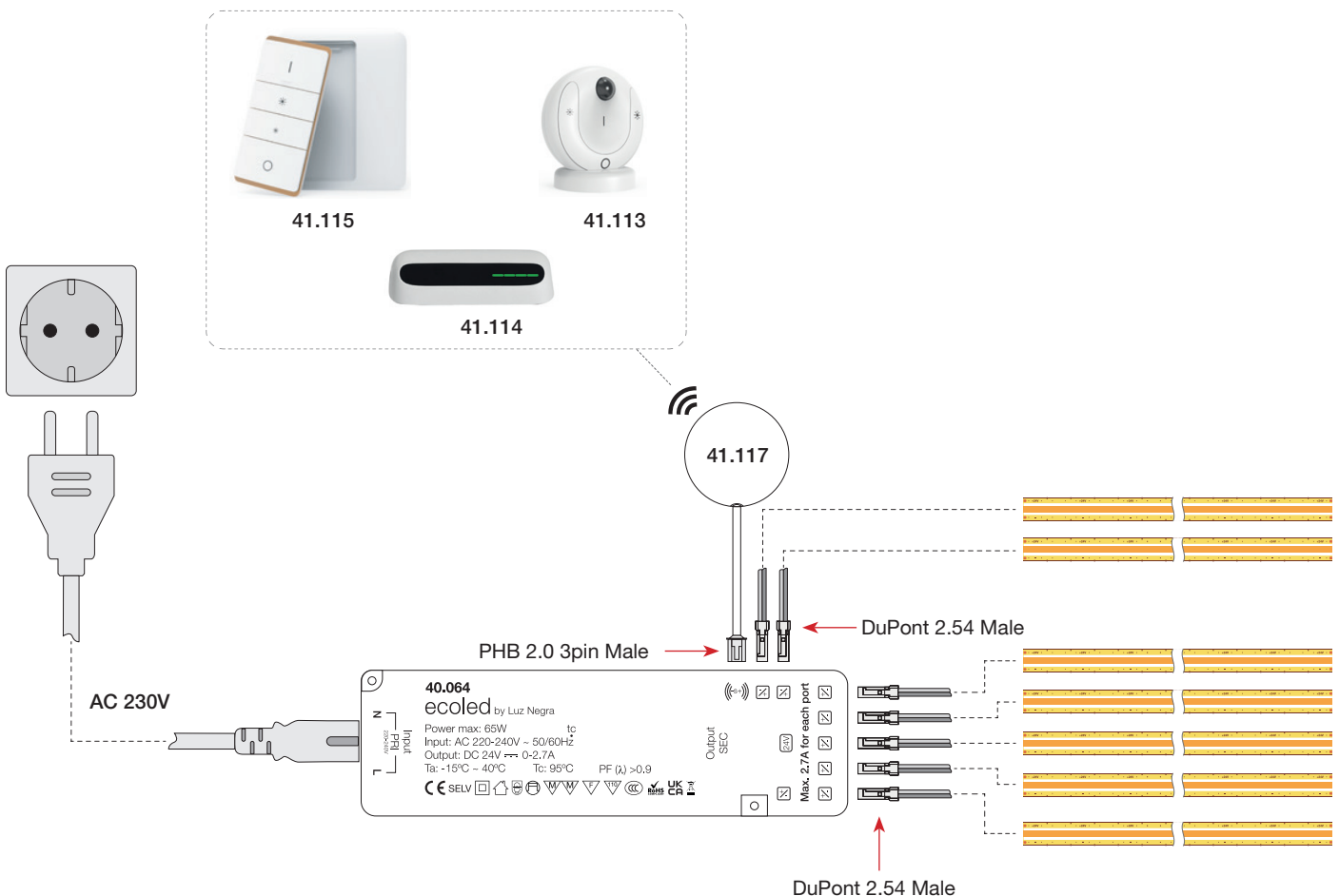

Connection

The Cut&Connect system features an innovative endcap that allows the power cable to be connected directly to the LED strip's PCB in a simple and secure way. The cap is inserted into the profile by pressure, meaning no soldering or tools required.

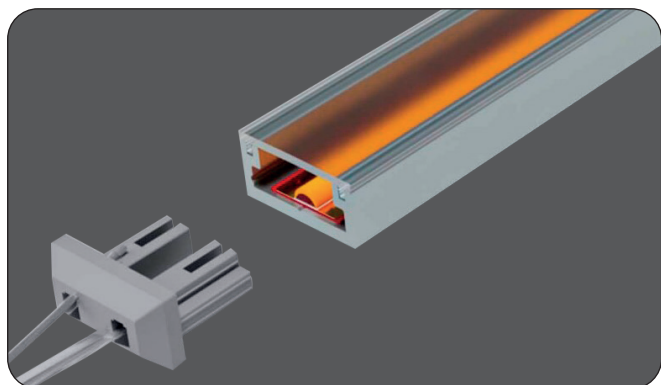

The 100cm power cable integrated into the cap includes, at the opposite end, a DuPont connector designed for easy connection to the power supply.

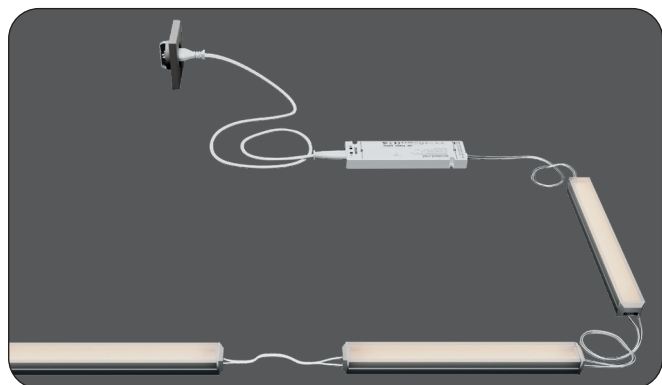
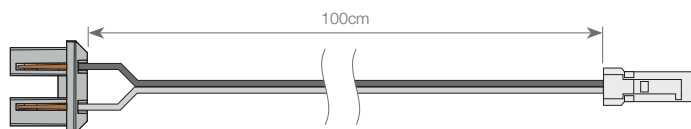

We also offer a 15cm cable with endcaps on both sides, allowing for quick and efficient connections between profiles. This accessory is available exclusively for the **Milano**, **Roma** and **Sophia** profiles.

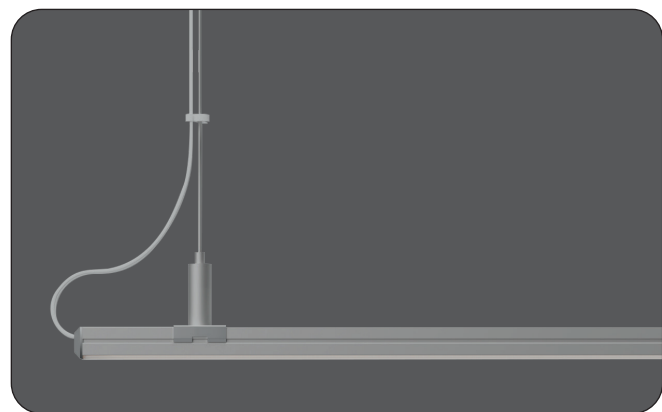
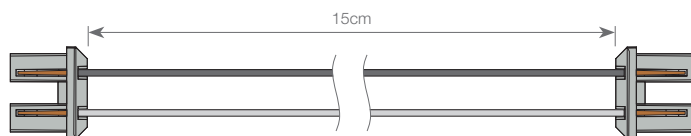

Additionally, Cut&Connect offers endcaps with a 300cm power cable, specifically designed for suspended luminaires where greater cable reach to the power supply is required. This accessory is available exclusively for the **Milano** and **Roma** profiles.

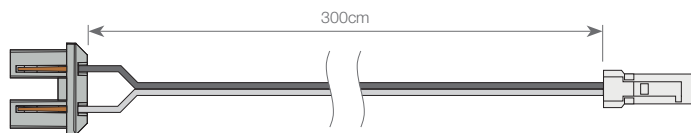

The endcaps through which the cable exits have a small recess beneath the connector, offering two cable exit options:



Standard horizontal exit: ideal for conventional installations.

Discreet vertical exit: allows the cable to exit vertically without protruding from the cap, making it easier to pass through surfaces such as wood, plasterboard, or other materials when the profile is installed in furniture or similar structures.

This practical and versatile design is available for the **Roma** and **Sophia** profiles.

Fixing elements:

Cut&Connect offers a wide range of mounting accessories and fixtures designed to suit various applications and luminaire functions:



Metal clips:

Ideal for quick and secure surface mounting.



Recessed brackets:

Perfect for installation in furniture, plasterboard walls or similar materials, ensuring a discreet and elegant integration.

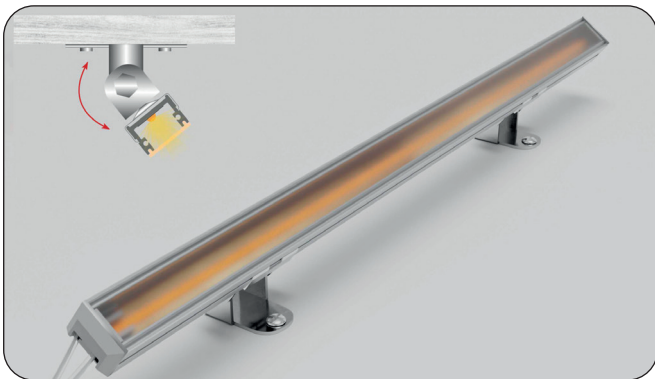

Adjustable brackets:

Allow surface mounting of the luminaire with the option to adjust its projection angle according to the needs of the project.



Adhesive magnetic strips:

Applied to the back of the luminaire, it enables easy attachment to metallic surfaces without the need for drilling.

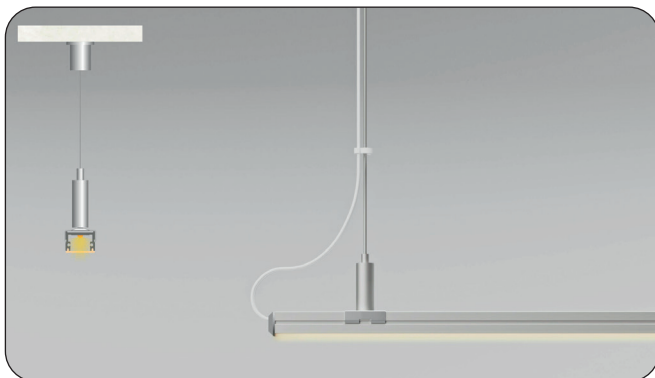

Suspension kits:

Designed for ceiling-suspended installations, ideal for projects that require a clean and professional finish.

This range of accessories ensures maximum versatility and adaptability for any type of installation.

Cut&Connect purchasing options available

Cut&Connect is available in 3 different alternatives:



Individual components:

Each component can be purchased separately: profiles, covers, LED strips, power supplies and accessories such as endcaps, clips and mounting fixtures.

Scan the QR code to access the individual components section on our website, where you can check the prices of all items (registration is required to view prices).



Recommended retail price (RRP) reference:

Conventional system: Milano profile in silver with frosted cover, 15W Elite LED, endcaps and clips:

Cut&Connect system: Milano profile in silver with frosted cover, 15W Elite GOLD LED, endcaps and clips:

Just 6% more than the conventional system, with a 75% saving in handling time and no soldering required.

Individual components:

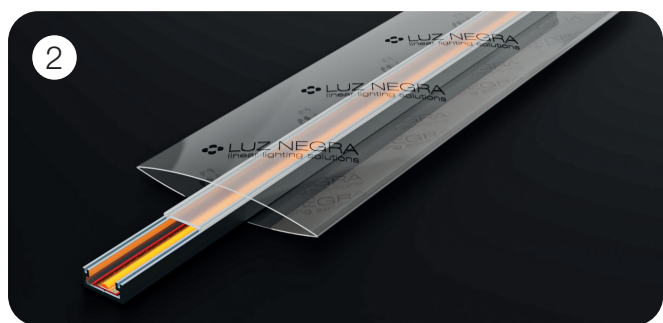

2m, 3m and 6m packs: Pre-assembled packs including profile, LED strip and cover in lengths of 2m, 3m and 6m. Choose your LED and cover which will come pre-installed in the profile and individually wrapped, ready to be cut to the desired length.

Additional items such as power supplies, endcaps, clips and accessories are sold separately.

RRP listed in the table.



Made to measure kits: Order your Cut&Connect luminaire fully customised, with 3 options to choose from:

- **Without power supply:** ideal if you want to use a single power supply for multiple luminaires.
- **With standard power supply:** for conventional installations.
- **With multi-connector power supply:** DuPont 2.54 connectors permit a quick, easy and tool-free installation.